



Rapido RTBH-1.19 *Market Specific*

Trolley Operator For Fast Standard Lift Sectional Doors

Heavy-Duty / High-Cycle / High-Speed

Architectural Shop Drawing

Project Details

Date: _____
 Drawing No.: _____
 Architect/Engineer: _____
 Customer: _____

Page: _____ of _____
 Project No.: _____
 Project Name: _____
 Contractor: _____

Dimensions & Ratings

Motor Amperage Rating			
Voltage - Phase			
HP	120V - 1PH	208V - 1PH	240V - 1PH
1	16.7	8.3	8.0

Reg. T.M. 9141-0720 Québec Inc.

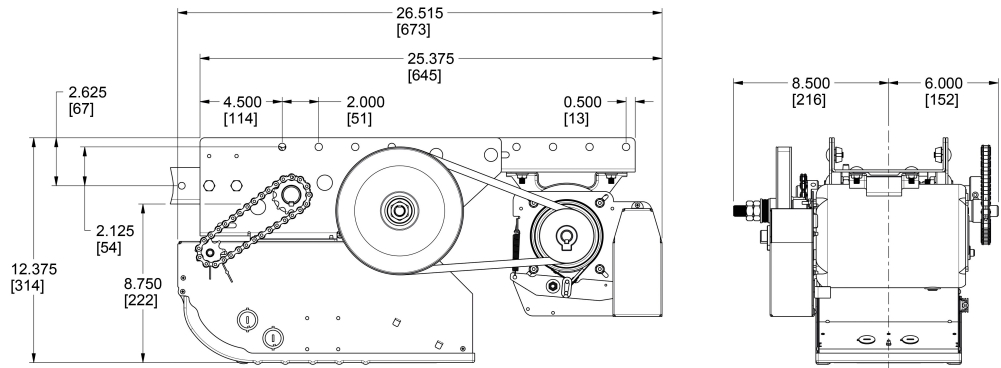

Ordering Specifications

Quantity: _____
 Horsepower (HP): 1 HP
 Phase: 1 Phase

Model: _____
 Volts: _____
 Hertz: 60 Hz

Door Type: _____
 Door Shaft Height: _____ H

Door Width/Height: _____ W x _____ H

Qty 3-PB Station(s)/Operator: _____
 (One 3-PB station supplied/operator unless otherwise noted)

3-Push Button Station Rating: _____

Motor Circuit Type: Electronic / Monitoring of Primary Entrapment Protection Device

