

⚠ WARNING

TO REDUCE THE RISK OF SEVERE INJURY OR DEATH TO PERSONS:

1. READ AND FOLLOW ALL INSTALLATION INSTRUCTIONS.
2. Always shut OFF the main power before performing any electrical intervention.
3. Photoelectric cells must be installed facing each other across the door's path within 6" (15 cm) of the plane of the door and the beam no more than 5-3/4" (14,6 cm) above the floor.

Components and Specifications

INTERFACE003 is a Y-Connect signal merging unit which allows for the connection of any two (2) Independent External Entrapment Protection Devices onto the MONITORED inputs of the operator's Electronic Control Board **BOARD070M**. With **INTERFACE003** properly installed, the operator receives an obstruction signal when either or both of the devices sense an obstruction. When no obstruction is present, **INTERFACE003** passes the standard dynamic signal to the operator. Refer to the Connections section on p.2 for further instructions.

Technical Specifications	
Protection Class	Nema 4
Housing Material	ABS/PA6 GF30; TPE
Housing Dimensions	3" L x 1-9/16" W x 1/2" H
Operation Temperature	-13 °F to 167 °F (-25 °C to 75°C)
Supply Voltage	24 VAC/DC
Power Consumption	< 15 mA
Response Time	33 ms obstruction time with secondary device

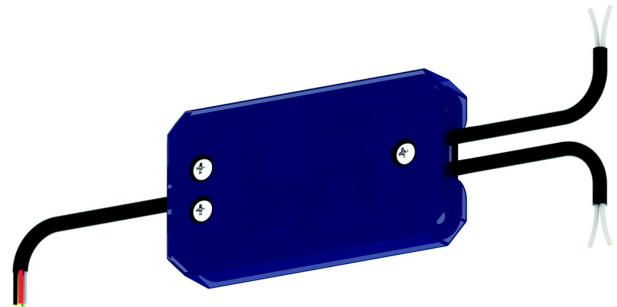

Figure 1: INTERFACE003

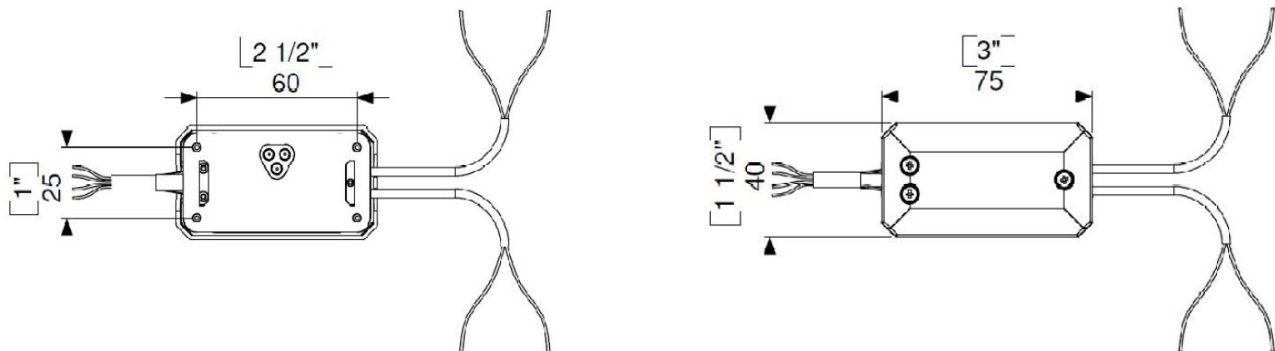







Figure 2 - Dimensions

INTERFACE003 - Y-Connect Module

Specifications and Installation Instructions

LED	Status	Description
YELLOW	 ON	Power ON
GREEN	 OFF	No Signal / Obstruction
YELLOW	 ON	Power ON
GREEN	 ON	Normal Operation
YELLOW	 OFF	Power OFF
GREEN	 OFF	Power OFF

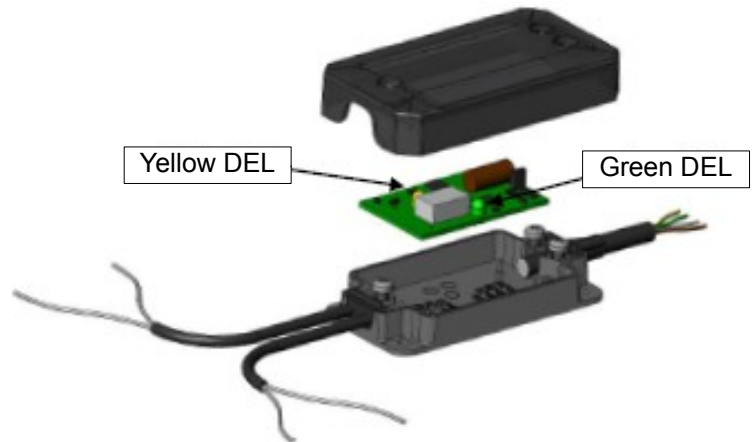

Figure 3: Exploded View with LEDs

Connections

Connect ANY TWO (2) independent UL 325 listed Monitored Entrapment Protection Devices simultaneously to the specific MONIT Terminals #15 and #16 on the Electronic Control Board BOARD 070M. Compatible devices include:

- Photo Electric Cells: PHOTO061/065/070
- Non-Contact Sensing Edges: PHOTO068A/068C
- Electric Sensing Edges: SENSEEDGE007UM/018UM/044UM
- Light Curtains: LIGHTCURTAIN001/002

Note:

- Never install TWO sets of photo electric cells within 45" of each other.
- To limit the cross talk between two sets of photo electric cells, alternate the position of the Transmitter and Receiver, such that, on the same side of the door there is a Transmitter from set #1 and a Receiver from set #2.
- An additional interface module may be required (INTERFACE002) when an electric sensing edge is used as one of the two Monitored Entrapment Protection Devices.

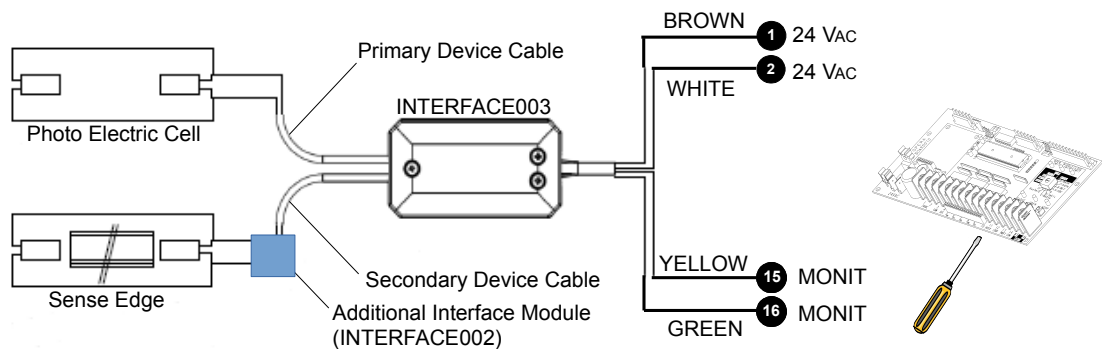

Figure 4 - Connection Diagram

For further information, please consult the operator's Installation & Instruction Manual or contact our Technical Support Department at **1-800-361-2260**.